

ADTT-TZKT Adjustable Deck Tension Tie Kit

Installation Instructions

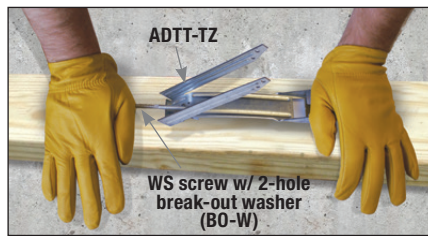

Method for opening ADTT-TZ

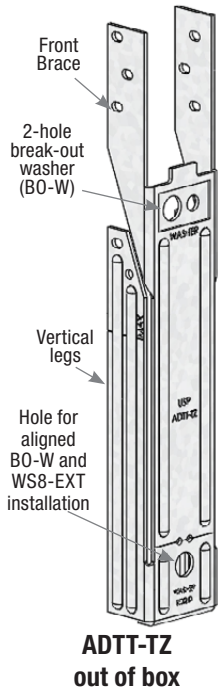
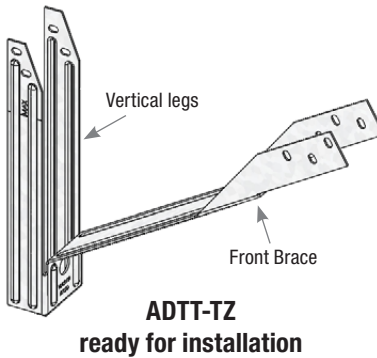

Step 1

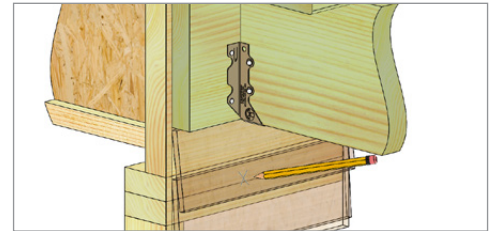

Determine location of interior framing for installation of USP's WS8-EXT screw. Mark that location on the exterior wall aligned with the deck joist and the interior wall framing. **Note:** The band joist is not an adequate attachment material.

Step 4

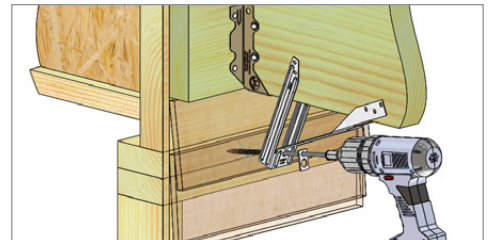

With the ADTT-TZ still attached, use a power driver to begin driving the screw into the structure at the location marked in step number 1. Drive screw horizontally and aligned vertically with the deck joist into structure approximately 3-in – 4-in allowing room for installation of the ADTT-TZ in front of the joist hanger seat (if present). There will be 4-in – 5-in of screw showing at the conclusion of this step. **Note:** Check with your siding manufacturer for recommendations for fastening through your siding material.

Step 2

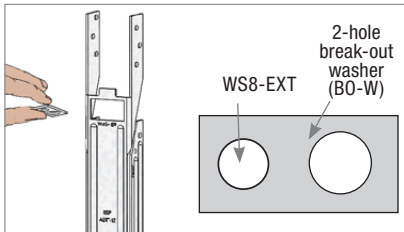

Use tool or blunt object to remove the 2-hole break-out washer (BO-W) from ADTT-TZ body. The WS8-EXT screw will utilize the smaller hole.

Step 3

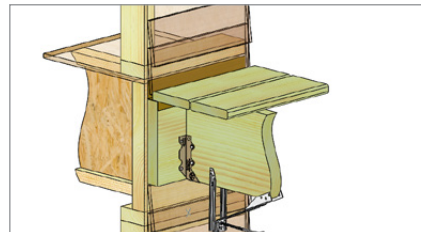

Thread the screw through BO-W and the large 7/16" hole at the base of the ADTT-TZ. Thread from the outside of the part. Bend front brace of ADTT-TZ away from vertical supports at approximately a 45° angle.

Step 5

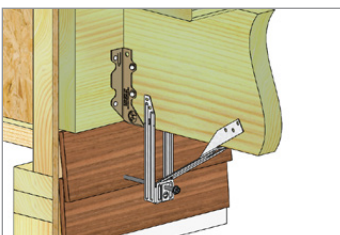

Align the vertical legs of the ADTT-TZ in a plumb position with the two leg flanges positioned on either side of the deck joist member. At this time, you will need to bend the front brace at the proper angle for installation.

Step 6

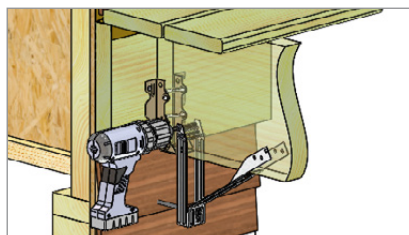

With the screw head and washer tight to the ADTT-TZ, install four (4) LL915 #9 x 1-3/8-in LumberLok screws into top flanges (Two (2) on each side of deck joist). Ensure that vertical legs and the body of the ADTT-TZ are kept in a vertical position during this step.

Step 7

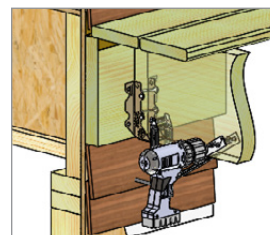

Bend front brace to proper angle so it is tight to the bottom side of the deck joist. Secure front brace with six (6) LL915 #9 x 1-3/8-in LumberLok screws.

Step 8

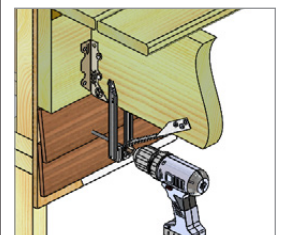

Re-tighten the WS8-EXT screw as needed to fully engage with the ADTT-TZ. **DO NOT OVERDRIVE**